

KillTest

更に上のクオリティ 更に上のサービス



問題集

<http://www.killtest.jp>

1年で無料進級することに提供する

Exam : **SY0-501**

Title : **CompTIA Security+**

Version : **DEMO**

1.DRAG DROP

A security administrator wants to implement strong security on the company smart phones and terminal servers located in the data center.

INSTRUCTIONS



Drag and drop the applicable controls to each asset type.

Controls can be used multiple times and not all placeholders need to be filled.

If at any time you would like to bring back the initial state of the simulation, please click the Reset All button.

Controls	Company Managed Smart Phone	Data Center Terminal Server
Screen Lock		
Strong Password		
Device Encryption		
Remote Wipe		
GPS Tracking		
Pop-up blocker		
Cable Locks		
Antivirus		
Host Based Firewall		
Proximity Reader		
Sniffer		
Mantrap		
		Reset All

Answer:

<p>Controls</p> <p>Screen Lock</p> <p>Strong Password</p> <p>Device Encryption</p> <p>Remote Wipe</p> <p>GPS Tracking</p> <p>Pop-up blocker</p> <p>Cable Locks</p> <p>Antivirus</p> <p>Host Based Firewall</p> <p>Proximity Reader</p> <p>Sniffer</p> <p>Mantrap</p>	<p>Company Managed Smart Phone</p>  <p>Screen Lock</p> <p>Strong Password</p> <p>Device Encryption</p> <p>Remote Wipe</p> <p>GPS Tracking</p> <p>Pop-up blocker</p>	<p>Data Center Terminal Server</p>  <p>Cable Locks</p> <p>Antivirus</p> <p>Host Based Firewall</p> <p>Proximity Reader</p> <p>Sniffer</p> <p>Mantrap</p>
	<p>Reset All</p>	

2.HOTSPOT

Select the appropriate attack from each drop down list to label the corresponding illustrated attack.











Instructions:

Attacks may only be used once, and will disappear from drop down list if selected.

When you have completed the simulation, please select the Done button to submit.

Attacks











**Instructions: Attacks may only be used once, and will disappear from drop down list if selected.
When you have completed the simulation, please select the Done button to submit.**

Attack Vector		Target	Identified Attack		
 <p>Attacker gains confidential company information</p>	➔	 <p>Targeted CEO and board members</p>	<div style="border: 1px solid #ccc; padding: 5px;"> <input type="text" value="SPIM"/> <ul style="list-style-type: none"> VISHING PHISHING WHALING HOAX PHARMING SPEAR PHISHING SPOOFING SPAM XMAS ATTACK </div>		
 <p>Attacker posts link to fake AV software</p>	➔	 <p>Multiple social networks</p>	➔	 <p>Broad set of victims</p>	<div style="border: 1px solid #ccc; padding: 5px;"> <input type="text" value="SPIM"/> <ul style="list-style-type: none"> VISHING PHISHING WHALING HOAX PHARMING SPEAR PHISHING SPOOFING SPAM XMAS ATTACK </div>
 <p>Attacker collecting credit card details</p>	➔	 <p>Phone-based victim</p>	<div style="border: 1px solid #ccc; padding: 5px;"> <input type="text" value="SPIM"/> <ul style="list-style-type: none"> VISHING PHISHING WHALING HOAX PHARMING SPEAR PHISHING SPOOFING SPAM XMAS ATTACK </div>		
 <p>Attacker mass-mails product information to parties that have already opted out of receiving advertisements</p>	➔	 <p>Broad set of recipients</p>	<div style="border: 1px solid #ccc; padding: 5px;"> <input type="text" value="SPIM"/> <ul style="list-style-type: none"> VISHING PHISHING WHALING HOAX PHARMING SPEAR PHISHING SPOOFING SPAM XMAS ATTACK </div>		
 <p>Attacker redirects name resolution entries from legitimate site to fraudulent site</p>	➔	 <p>Victims</p>	<div style="display: flex; align-items: center; gap: 10px;"> <div style="border: 1px solid #ccc; padding: 2px;">➔ Fraudulent site</div> <div style="border: 1px solid #ccc; padding: 2px;">➔ Legitimate site</div> </div> <div style="border: 1px solid #ccc; padding: 5px; margin-top: 5px;"> <input type="text" value="WHALING"/> <ul style="list-style-type: none"> SPIM VISHING PHISHING WHALING HOAX PHARMING SPEAR PHISHING SPOOFING SPAM XMAS ATTACK </div>		

Answer:

Attacks

Instructions: Attacks may only be used once, and will disappear from drop down list if selected. When you have completed the simulation, please select the Done button to submit.

Attack Vector	Target	Identified Attack
 <p>Attacker gains confidential company information</p>	 <p>Targeted CEO and board members</p>	<ul style="list-style-type: none"> SPIM VISHING PHISHING WHALING HOAX PHARMING <li style="background-color: #e0ffe0;">SPEAR PHISHING SPOOFING SPAM XMAS ATTACK
 <p>Attacker posts link to fake AV software</p>	 <p>Multiple social networks</p>  <p>Broad set of victims</p>	<ul style="list-style-type: none"> SPIM VISHING PHISHING WHALING <li style="background-color: #e0ffe0;">HOAX PHARMING SPEAR PHISHING SPOOFING SPAM XMAS ATTACK
 <p>Attacker collecting credit card details</p>	 <p>Phone-based victim</p>	<ul style="list-style-type: none"> SPIM <li style="background-color: #e0ffe0;">VISHING PHISHING WHALING HOAX PHARMING SPEAR PHISHING SPOOFING SPAM XMAS ATTACK
 <p>Attacker mass-mails product information to parties that have already opted out of receiving advertisements</p>	 <p>Broad set of recipients</p>	<ul style="list-style-type: none"> SPIM VISHING PHISHING WHALING HOAX PHARMING SPEAR PHISHING SPOOFING <li style="background-color: #e0ffe0;">SPAM XMAS ATTACK
 <p>Attacker redirects name resolution entries from legitimate site to fraudulent site</p>	 <p>Victims</p> <div style="display: flex; align-items: center; gap: 10px;"> <div style="border: 1px solid red; padding: 2px;">Fraudulent site</div> <div style="border: 1px solid green; padding: 2px;">Legitimate site</div> </div>	<ul style="list-style-type: none"> WHALING SPIM VISHING PHISHING WHALING HOAX <li style="background-color: #e0ffe0;">PHARMING SPEAR PHISHING SPOOFING SPAM XMAS ATTACK

Explanation:

1: Spear phishing is an e-mail spoofing fraud attempt that targets a specific organization, seeking unauthorized access to confidential data. As with the e-mail messages used in regular phishing expeditions, spear phishing messages appear to come from a trusted source. Phishing messages usually appear to come from a large and well-known company or Web site with a broad membership base, such as eBay or PayPal. In the case of spear phishing, however, the apparent source of the e-mail is likely to be an individual within the recipient's own company and generally someone in a position of authority.

2: The Hoax in this question is designed to make people believe that the fake AV (anti- virus) software is genuine.

3: Vishing is the act of using the telephone in an attempt to scam the user into surrendering private information that will be used for identity theft. The scammer usually pretends to be a legitimate business, and fools the victim into thinking he or she will profit.

4: Email spam, also referred to as junk email, is unsolicited messages sent in bulk by email (spamming).

5: Similar in nature to e-mail phishing, pharming seeks to obtain personal or private (usually financial related) information through domain spoofing. Rather than being spammed with malicious and mischievous e-mail requests for you to visit spoof Web sites which appear legitimate, pharming 'poisons' a DNS server by infusing false information into the DNS server, resulting in a user's request being redirected elsewhere. Your browser, however will show you are at the correct Web site, which makes pharming a bit more serious and more difficult to detect. Phishing attempts to scam people one at a time with an e-mail while pharming allows the scammers to target large groups of people at one time through domain spoofing.

References:

<http://searchsecurity.techtarget.com/definition/spear-phishing>

<http://www.webopedia.com/TERM/V/vishing.html>

<http://www.webopedia.com/TERM/P/phishing.html>

<http://www.webopedia.com/TERM/P/pharming.html>

3.DRAG DROP

You have been tasked with designing a security plan for your company.

INSTRUCTIONS

Drag and drop the appropriate security controls on the floor plan.

All objects must be used and all place holders must be filled. Order does not matter.

If at any time you would like to bring back the initial state of the simulation, please click the Reset All button.

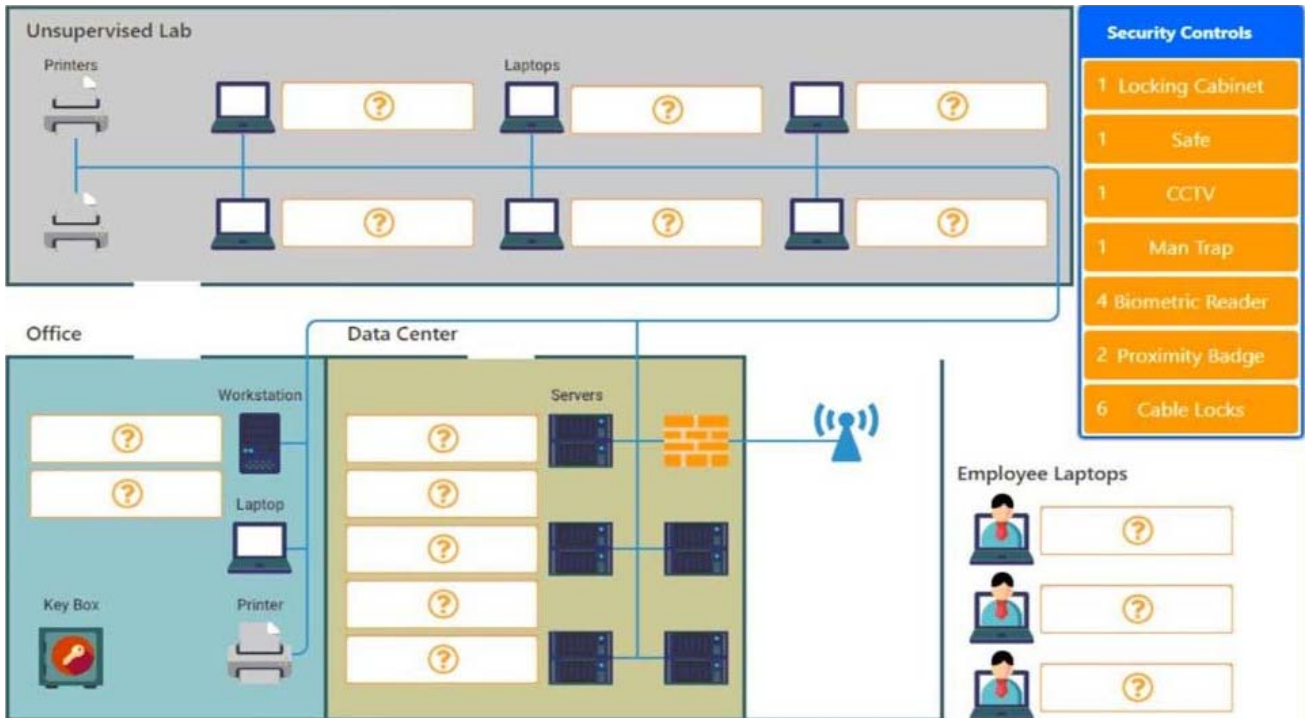

Answer:

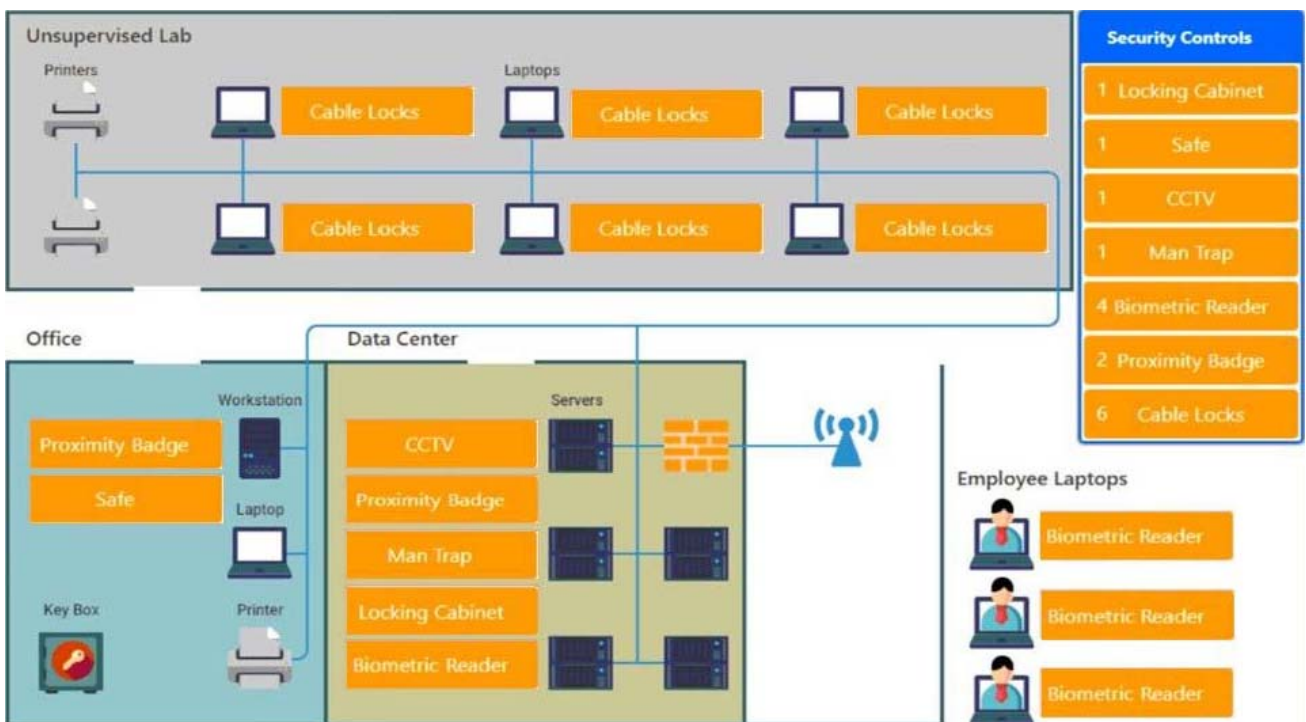

Explanation:

Cable locks - Adding a cable lock between a laptop and a desk prevents someone from picking it up and walking away

Proximity badge + reader

Safe is a hardware/physical security measure

Mantrap can be used to control access to sensitive areas.

CCTV can be used as video surveillance.

Biometric reader can be used to control and prevent unauthorized access.

Locking cabinets can be used to protect backup media, documentation and other physical artefacts.

4.Which of the following would a security specialist be able to determine upon examination of a server's certificate?

- A. CA public key
- B. Server private key
- C. CSR
- D. OID

Answer: D

5.A security analyst is diagnosing an incident in which a system was compromised from an external IP address. The socket identified on the firewall was traced to 207.46.130.0:6666.

Which of the following should the security analyst do to determine if the compromised system still has an active connection?

- A. tracert
- B. netstat
- C. ping
- D. nslookup

Answer: B