

# *KillTest*

更に上のクオリティ 更に上のサービス



## 問題集

<http://www.killtest.jp>

1年で無料進級することに提供する

**Exam** : **920-569**

**Title** : nncds-optera metro  
solutions

**Version** : DEMO

1. What do long haul networks use to traverse long distances without regeneration?

- A. Q adapters coupled with optical amplifiers
- B. high power transmitters coupled with OSC receivers
- C. 3R amplification tables coupled with long reach lasers
- D. dispersion compensation modules coupled with Raman amplifiers

Answer: D

2. What are two advantages that a 4-fiber BLSR has over a 2-fiber BLSR? (Choose two.)

- A. more survivable
- B. double fiber use
- C. lower initial cost
- D. double the bandwidth

Answer:AD

3. Your customer is a carrier for an enterprise client who has an IP network running Gigabit Ethernet services. Your customer wants to expand their network offering to include connectivity to three other sites in a metropolitan area, using the same fiber infrastructure. Which two services meet these requirements? (Choose two.)

- A. Private line service
- B. Optical Ethernet service
- C. Channel Extension service
- D. Managed Wavelength service
- E. DSL-based Internet Access service

Answer: BD

4. Your customer is deploying an optical network in the continental United States. The customer requires a SONET ring topology. The 4 add/drop sites (clockwise, starting from the north) are: Site 1: North City Site 2: East City Site 3: South City Site 4: West City Each of these add/drop sites can either be externally timed, internally timed or tributary/line timed. The customer requires that external synchronization sources be located in East City and West City. What is the most robust priority order of synchronization sources for the specified major add/drop site?

- A. North City: internal timing source, line timed from East City, line timed from West City

B. North City: line timed from West City, internal timing source, line timed from East City

C. South City: line timed from East City, line timed from West City, internal timing source D. South City: internal timing source, line timed from West City, line timed from East City

Answer: C

5. Given the following: 0.5 dB connector loss 0.45 dB loss per mile 2 dB customer margin Transmitter power -2.0 dBm Receiver sensitivity -22 dBm Fusion splice loss is 0.04 dB. Dispersion penalty = 0.2dB per 10 miles Passthrough has two connectors. You have a point-to-point optical system that has two connectors on each end, one passthrough, and two splices. What is the maximum span loss that can be sustained?

A. 13.92 dB

B. 14.92 dB

C. 16.92 dB

D. 18.00 dB

E. 20.00 dB

Answer: B

6. Given the following: 0.5 dB connector loss 0.33 dB loss per mile 2 dB customer margin Transmitter power -1.5 dBm Receiver sensitivity -22 dBm Fusion splice loss is 0.04 dB. Dispersion penalty = 0.2 dB per 10 miles Passthrough has two connectors. Optical Multiplexer has 2.2 dB drop loss. Optical Multiplexer has 2.8 dB add loss. You have a point-to-point hybrid OC-48/Multiplexer system. Each OC-48 feeds into an Optical Multiplexer; the OC-48s have one connector each; and the Optical Multiplexers have two connectors each. There are also two splices in the network. The total link distance is 22 miles. What is the total dB loss between sites?

A. 15.13.dB

B. 15.33.dB

C. 17.94.dB

D. 22.74.dB

E. 22.94.dB

Answer: C

7. Click the Exhibit button. Given that the ring in the exhibit is UPSR, and given the traffic shown at each site, what minimum line rate is required (assuming STS-1 management)?

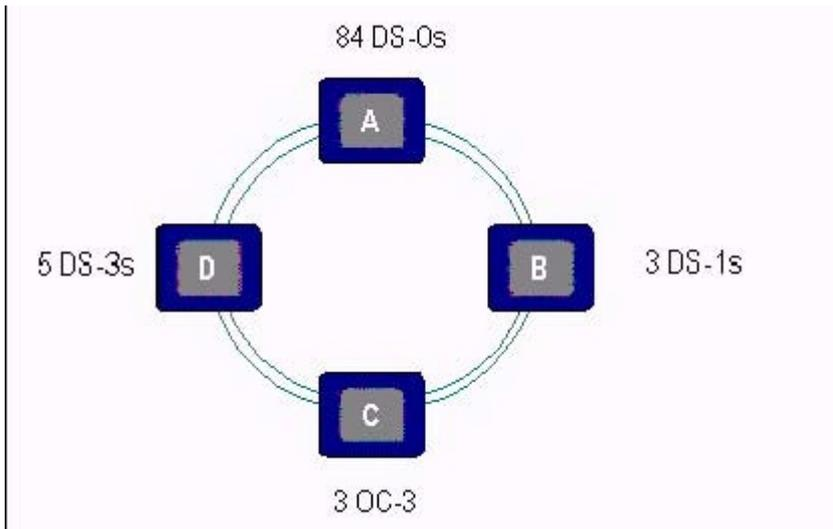

- A. OC-3c
- B. OC-12
- C. OC-48
- D. OC-192

Answer: C

8. Which architecture guards against multiple concurrent faults on the same network?

- A. UPSR
- B. 2-fiber BLSR
- C. 4-fiber BLSR
- D. 1+1 protection
- E. 1:N protection

Answer: C

9. Which sequence of protection schemes is listed in the order of highest to lowest robustness?

- A. 4 fiber BLSR, 2 fiber BLSR, UPSR, IEEE802.1D
- B. 4 fiber BLSR, 2 fiber BLSR, IEEE802.1D, UPSR
- C. 4 fiber BLSR, IEEE802.1D, 2 fiber BLSR, UPSR
- D. 4 fiber BLSR, UPSR, 2 fiber BLSR, IEEE802.1D

E. IEEE802.1D, 4 fiber BLSR, 2 fiber BLSR, UPSR

Answer:A

10. A customer would like to implement a 3-site DWDM network. Sites 1 and 2 will provide access to all the traffic and Site 3 will be adding/dropping a portion of the traffic. To keep the cost to a minimum, the customer would like to lease only a pair of fiber between the sites. What network topology would be best suited for this customer network?

- A. Meshed ring
- B. Hubbed ring
- C. Linear OADM
- D. Point to point

Answer: C

11. Click the Exhibit button. Given the diagram shown in the exhibit and the following information: Nortel Networks OPTera Metro product Multiplexer passthrough loss = 0.9 dB Multiplexer add loss = 2.8 dB Multiplexer drop loss = 2.2 dB Customer margin per optical span = 2 dB Dispersion + Jitter penalty = 0.09 dB per km Fiber loss = 0.6 dB per km No optical amplifiers Transmitter output power = 0.0 dB You have a 2.5G customer input on an OADM 1 Band 4 going counterclockwise to OADM 7 Band 4. What is the total loss in dB?

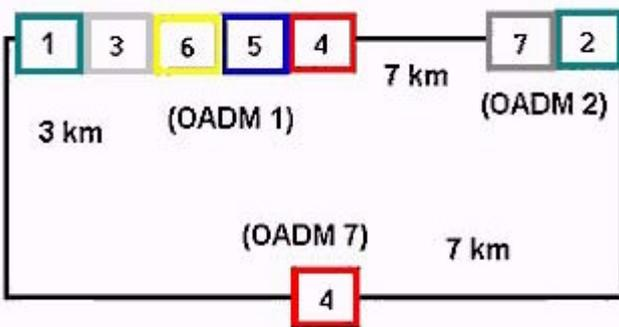

- A. 11.34 dB
- B. 12.40 dB
- C. 12.67 dB
- D. 13.33 dB
- E. 13.67 dB

Answer: C

12. Click the Exhibit button. You have designed an optically protected, diversely routed DWDM network and have positioned the optical amplifiers and regenerators as dictated by the wavelength traffic flow and fiber characterization. Which two equalization methods are valid? (Choose two.)

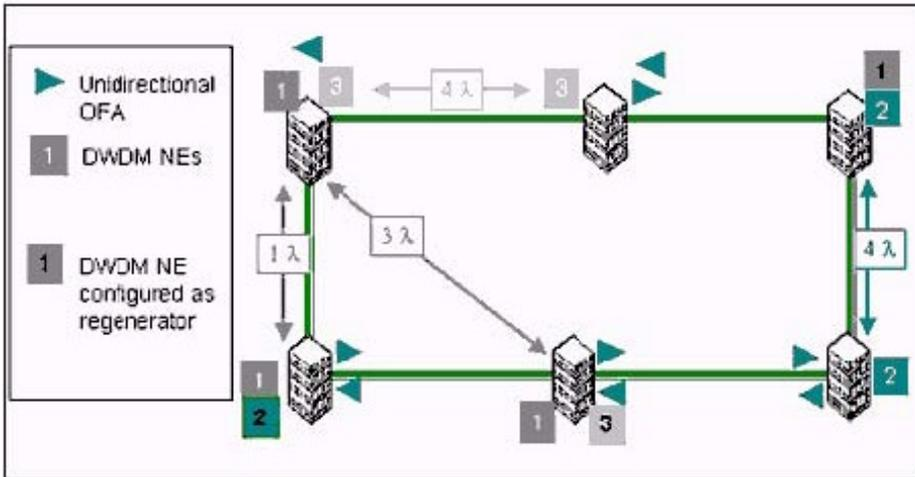

- A. passive equalization
- B. distributed equalization
- C. centralized equalization
- D. synchronized equalization

Answer: BC

13. Click the Exhibit button. Given the following information, does the network meet the link budget? ?  
 OM3500 network with Band 1 Channel 1 and Band 1 Channel 2 deployed as shown in the diagram ?  
 OMX add loss: 4 dB ? OMX drop loss: 4 dB ? OMX pass through loss: 1.6 dB ? Rx sensitivity: -27.9 dB ?  
 Tx power: 0 dB

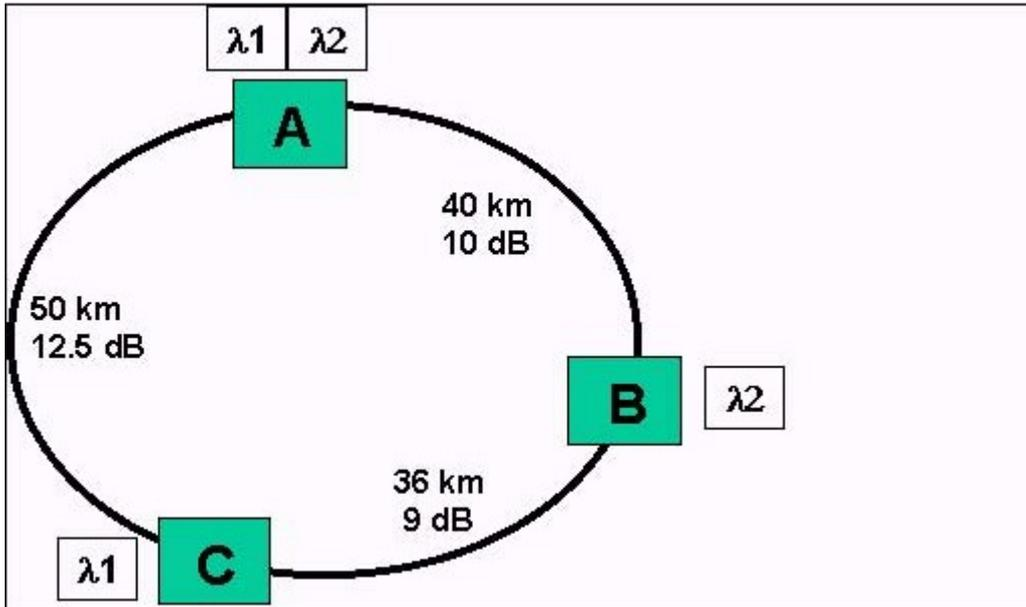

- A. Yes. The unamplified network meets link budgets in all spans.
- B. No. A clockwise pre-amp at site C and a counter-clockwise pre-amp at site B must be added to meet link budgets in all spans.
- C. No. A clockwise pre-amp and a counter-clockwise post-amp at site C must be added to meet link budgets in all spans.
- D. No. A clockwise and counterclockwise post-amp at Site A would enable the network to meet link budgets in all spans.

Answer:A

14. A new CLEC wants to build a core metropolitan optical network for 13 sites within a city. Only one fiber pair is available between sites in a single ring configuration. The CLEC expects high demand growth and wants to have DWDM capabilities built in the network from day one. Which product can readily be deployed over this single ring to build the optical network and provide the DWDM capability?

- A. OPTera Metro 5100 and possibly OFA modules
- B. OPTera Metro 3100 with OMX and possibly OFA modules
- C. OPTera Metro 3400 with OMX and possibly OFA modules
- D. OPTera Metro 3500 with OMX and possibly OFA modules

Answer: D

15. Click the Exhibit button. A SAN service provider needs to increase the bandwidth capacity in Metro city A. Sites A, B, and C are customer nodes. All traffic terminates at Site H (hub). All tributary ports are

unprotected. All non-Gigabit Ethernet traffic should be path protected. (Fiber Channel rate = 1.062 Gbits/s.) Which OPTera Metro 5200 client interface would interface with the Fiber Channel ports?

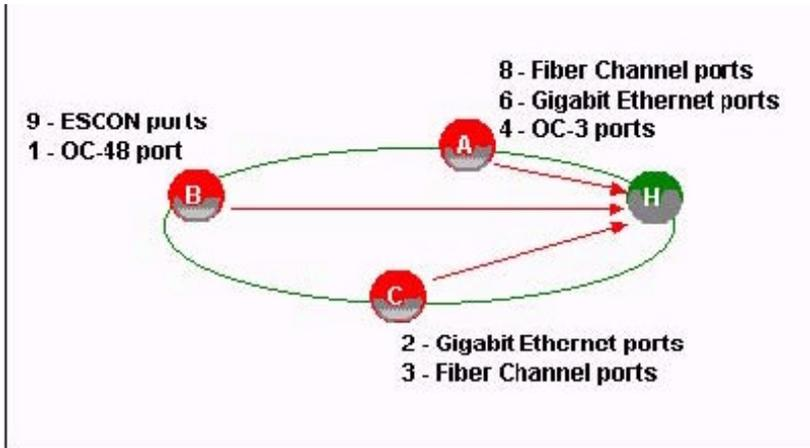

- A. SRM OCI
- B. 1.25 Gbits/s OCI
- C. 2.5 Gbits/s transponder
- D. SONET/SDH OCI multiplexer

Answer: B

16. Click the Exhibit button. An ISP has a regional optical network built using OPTera Metro 5200 and NDSF fiber with a loss of 0.30 dB per kilometer. The traffic pattern and the allocated bands within the system are meshed. Connector losses are included in the fiber losses. What is the total for all losses and penalties between Tx and Rx for Band 1 (B1) in the clockwise direction between Sites A and C and is an optical amplifier required for B1 over that link?

2.5Gbits/s configuration  
 OMX add loss: 3.3dB  
 OMX drop loss: 3.9dB  
 Shelf passthrough losses: 1.2dB  
 Minimum Tx power: 3.3dB  
 Minimum Rx sensitivity: -25.8dB  
 Jitter penalty: 0.95dB  
 Dispersion penalty: 1.52dB

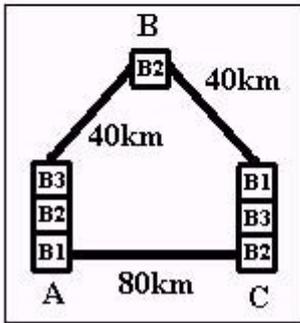

- A. 28.87 dB; (There is no need for an amplifier because the un-amplified optical link budget is not exceeded.)
- B. 28.87 dB; (An amplifier is required for that link because the un-amplified optical link budget is exceeded.)
- C. 37.27 dB; (There is no need for an amplifier because the un-amplified optical link budget is not exceeded.)
- D. 37.27 dB; (An amplifier is required for that link because the un-amplified optical link budget is exceeded.)

Answer: D

17. Click the Exhibit button. A CLEC customer is interested in backhaul of leased T1 and T3 traffic from several ILEC collocation sites (B-D) to its Metro point of presence located at Site A. Approximately 30% (ports) of the leased traffic is handed off to its IXC partner (Site X) as bulk mapped DS3s. The customer has leased two fibers from a fiber provider to provide for this backhaul application. The fiber route allows for interconnection with all of these sites. Which product provides the required features and an opportunity for growth?

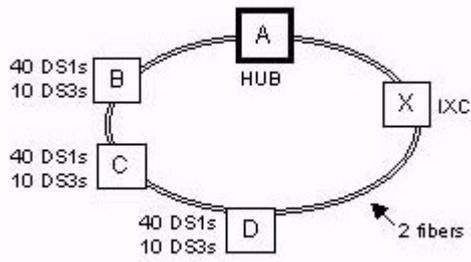

- A. OPTera Connect DX
- B. OPTera Metro 5200
- C. OPTera Metro 3400 with DWDM
- D. OPTera Metro 3500 with DWDM

Answer: D

18. Click the Exhibit button. A customer wants suggestions on alternate approaches on an OPTera Metro 5200 design. The customer is strongly opposed to the use of amplifiers and wants to design for minimum extra capacity. The distance between sites is 30 miles (48 kilometers). Which statement is true?

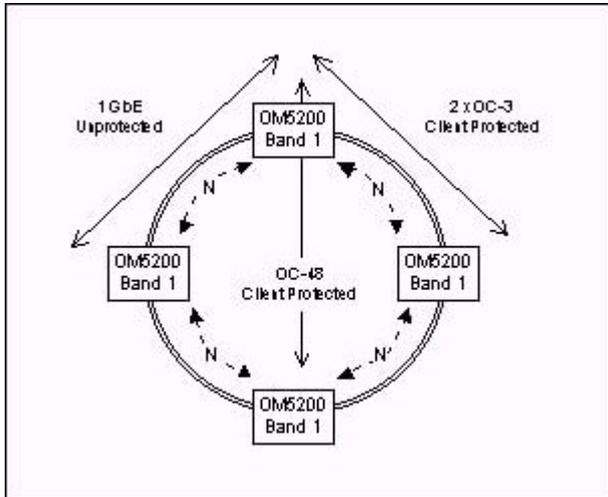

- A. The design is well suited to the application because it offers electrical regeneration at each site to reduce amplifier requirements.
- B. The design is optimal because it minimizes the total number of OCLDs used, reserving space for future growth.
- C. You should suggest changing the design to bands dedicated for non-hub sites to reduce cost and reduce amplifier requirements.

D. You should suggest separating protected and unprotected traffic on different bands to optimize the design for the longer protection paths.

Answer:A

19. Click the Exhibit button. An enterprise has two data centers linked together using OPTera Metro 5200 equipped with Fiber Channel client interfaces (tributaries). The configuration is for an unprotected point-to-point connection. Three C-Bands shelves are used and pre-amplification is required as shown in the exhibit. Channels are still available on all of the three bands for additional traffic. The customer wants to add un-protected Gigabit Ethernet capability to the network. Which solution could be recommended to provide the function most cost-effectively?

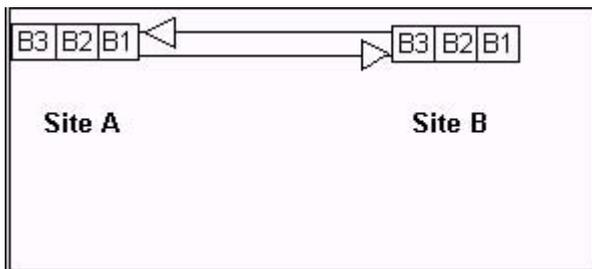

- A. adding Gigabit Ethernet OCIs to the existing OPTera Metro 5200 shelves
- B. OPTera Metro 3500 shelves at each end equipped with Gigabit Ethernet cards
- C. Passport 8600 units at each end fanning in multiple 100BaseT client connections
- D. OC-48 TransportNode (Classic) shelves at each end equipped with Gigabit Ethernet cards

Answer:A

20. The director of technical resources for an enterprise has requested that you explain to his staff what considerations are important for network survivability with OPTera Metro 3000 and 5000 series. As an example, equipment protection (i.e., 1:N, 1+1, 1:1) eliminates the possibility that a \_\_\_\_\_ will interrupt services.

- A. fiber cut
- B. single hardware failure
- C. double hardware failure
- D. network processor failure

Answer: B